



PhilGEPS

Philippine Government Electronic Procurement System

Central Portal for
Philippine Government
Procurement Opportunities

[Help](#)

Bid Notice Abstract

Invitation to Bid (ITB)

Reference Number 7841810
Procuring Entity CARLOS HILADO MEMORIAL STATE COLLEGE
Title Upgrading of TVEP Building - Phase 1 (Labor and Materials) - Alijis Campus, Brgy. Alijis, Bacolod City, Negros Occidental
Area of Delivery Negros Occidental

Solicitation Number:	CHMSC 21-035-0713-I	Status	Pending
Trade Agreement:	Implementing Rules and Regulations	Associated Components	8
Procurement Mode:	Public Bidding	Bid Supplements	0
Classification:	Civil Works	Document Request List	0
Category:	Construction Projects	Date Published	14/07/2021
Approved Budget for the Contract:	PHP 1,799,975.88	Last Updated / Time	13/07/2021 16:38 PM
Delivery Period:	90 Day/s	Closing Date / Time	03/08/2021 09:30 AM
Client Agency:			
Contact Person:	Ma. Lorena Fernandez Jugos Administrative Assistant II Mabini Street, Brgy Zone 1 Talisay City Negros Occidental Philippines 6115 63-34-7128404 63-34-7128404 chmsc_bacsec@yahoo.com		

Description

CARLOS HILADO MEMORIAL STATE COLLEGE
BIDS AND AWARDS COMMITTEE
Talisay City, Negros Occidental
Telefax Nos. (034)712-8404

INVITATION TO BID
FOR UPGRADING OF TVEP BUILDING - PHASE 1 (LABOR AND MATERIALS) - ALIJIS CAMPUS, BRGY. ALIJIS,
BACOLOD CITY, NEGROS OCCIDENTAL
CHMSC 21-035-0713-I

1. The Carlos Hilado Memorial State College, through the Corporate Budget for the Contract of 2021 approved by the governing Board, intends to apply the sum of ONE MILLION SEVEN HUNDRED NINETY-NINE THOUSAND NINE HUNDRED SEVENTY-FIVE PESOS & 88/100 (Php 1,799,975.88) ONLY being the Approved Budget for the Contract (ABC) to payments under the contract for UPGRADING OF TVEP BUILDING - PHASE 1 (LABOR AND MATERIALS) - ALIJIS CAMPUS, BRGY. ALIJIS, BACOLOD CITY, NEGROS OCCIDENTAL. Bids received in excess of the ABC shall be automatically rejected at bid opening.

2. The Carlos Hilado Memorial State College now invites bids for the above Procurement Project. Completion of the Works is required within Ninety (90) calendar days upon receipt of Notice to Proceed. Bidders should have completed a contract similar to the Project. The description of an eligible bidder is contained in the Bidding Documents, particularly, in Section II (Instructions to Bidders).

3. Bidding will be conducted through open competitive bidding procedures using the non-discretionary "pass/fail" criterion as specified in the 2016 revised Implementing Rules and Regulations (IRR) of Republic Act (RA) No. 9184.

4. Interested bidders may obtain further information from CARLOS HILADO MEMORIAL STATE COLLEGE and inspect the Bidding Documents at the address given below from 8:00 A.M. to 5:00 P.M.

5. A complete set of Bidding Documents may be acquired by interested bidders on July 14 – August 3, 2021 (9:00 A.M.) from given address and website/s below and upon payment of the applicable fee for the Bidding Documents, pursuant to the latest Guidelines issued by the GPPB, in the amount of Five Thousand Pesos (Php 5,000.00) Only. The Procuring Entity shall allow the bidder to present its proof of payment for the fees.
6. The CHMSC will hold a Pre-Bid conference on 10:00 A.M., July 21, 2021 at Bidding Room, 2/F Supply and Property Management Bldg., Brgy. Zone 1, Mabini St., Talisay City, Negros Occidental and or through video conferencing or webcasting via Zoom Meeting with ID No. 797 389 7583, Meeting Password 072121, which shall be open to prospective bidders.
7. Bids must be duly received by the BAC Secretariat through (i) manual submission at the office address as indicated below, (ii) online or electronic submission as indicated below, or (iii) both on or before 9:30 A.M., August 3, 2021. Late bids shall not be accepted.
- Bids may be submitted through electronic mail to bac.sec@chmsc.edu.ph provided that the bidding documents are compressed into two (2) separate archived folders (zip or rar format) and which each folder shall be labelled as "First Envelope_Name of Company_Project Reference Number" and "Second Envelope_Name of Company_Project Reference Number" and each is uniquely password-protected;
- Bidders must submit the printed copies (Original, Copy 1 and Copy 2) of their bidding documents within 3 calendar days from bid opening.
8. All Bids must be accompanied by a bid security in any of the acceptable forms and in the amount stated in ITB Clause 16.
9. Bid opening shall be on 10:00 A.M., August 3, 2021 at the Bidding Room, 2/F Supply and Property Management Bldg., Brgy. Zone 1, Mabini St., Talisay City, Negros Occidental and/or through Zoom Meeting ID No. 797 389 7583, Meeting Password 080321. Bids will be opened in the presence of the bidders' representatives who choose to attend the activity.
10. The Carlos Hilado Memorial State College reserves the right to reject any and all bids, declare a failure of bidding, or not award the contract at any time prior to contract award in accordance with Sections 35.6 and 41 of the 2016 revised Implementing Rules and Regulations (IRR) of RA No. 9184, without thereby incurring any liability to the affected bidder or bidders.
11. For further information, please refer to:

MISS LIGAYA E. FUENTES
 Head, BAC Secretariat
 Carlos Hilado Memorial State College
 Bidding Room, 2/F Supply and Property Management Bldg.
 Brgy. Zone 1, Mabini St.,
 Talisay City, Negros Occidental
 Email Add.: bac.sec@chmsc.edu.ph
 Telefax No. (034) 712-8404
 Website: chmsc.edu.ph

12. You may visit the following websites:

For downloading of Bidding Documents: chmsc.edu.ph

For online bid submission: bac.sec@chmsc.edu.ph

EDWIN H. BUGNA, Ph.D.TM.
 BAC Chairperson

Line Items

Item No.	Product/Service Name	Description	Quantity	UOM	Budget (PHP)
1	ONE (1) LOT	Upgrading of TVEP Building - Phase 1 (Labor and Materials)	1	Lot	1,799,975.88

Pre-bid Conference

Date	Time	Venue
21/07/2021	10:00:00 AM	Bidding Room, 2/F Supply and Property Management Bldg., Brgy. Zone 1, Mabini St., Talisay City, Negros Occidental Zoom Meeting with ID No. 797 389 7583, Meeting Password 072121

Date Created

13/07/2021

The PhilGEPS team is not responsible for any typographical errors or misinformation presented in the system. PhilGEPS only displays information provided for by its clients, and any queries regarding the postings should be directed to the contact person/s of the concerned party.

© 2004-2021 DBM Procurement Service. All rights reserved.

[Help](#) | [Contact Us](#) | [Sitemap](#)



CARLOS HILADO MEMORIAL STATE COLLEGE
BIDS AND AWARDS COMMITTEE
Talisay City, Negros Occidental
Telefax Nos. (034)712-8404



INVITATION TO BID
FOR UPGRADING OF TVEP BUILDING - PHASE 1 (LABOR AND MATERIALS) – ALIJIS CAMPUS,
BRGY. ALIJIS, BACOLOD CITY, NEGROS OCCIDENTAL
CHMSC 21-035-0713-I

1. The *Carlos Hilado Memorial State College*, through the *Corporate Budget for the Contract of 2021 approved by the governing Board*, intends to apply the sum of **ONE MILLION SEVEN HUNDRED NINETY-NINE THOUSAND NINE HUNDRED SEVENTY-FIVE PESOS & 88/100 (Php 1,799,975.88) ONLY** being the Approved Budget for the Contract (ABC) to payments under the contract for **UPGRADING OF TVEP BUILDING - PHASE 1 (LABOR AND MATERIALS) – ALIJIS CAMPUS, BRGY. ALIJIS, BACOLOD CITY, NEGROS OCCIDENTAL**. Bids received in excess of the ABC shall be automatically rejected at bid opening.
2. The *Carlos Hilado Memorial State College* now invites bids for the above Procurement Project. Completion of the Works is required within **Ninety (90) calendar days upon receipt of Notice to Proceed**. Bidders should have completed a contract similar to the Project. The description of an eligible bidder is contained in the Bidding Documents, particularly, in Section II (Instructions to Bidders).
3. Bidding will be conducted through open competitive bidding procedures using the non-discretionary “pass/fail” criterion as specified in the 2016 revised Implementing Rules and Regulations (IRR) of Republic Act (RA) No. 9184.
4. Interested bidders may obtain further information from **CARLOS HILADO MEMORIAL STATE COLLEGE** and inspect the Bidding Documents at the address given below from 8:00 A.M. to 5:00 P.M.
5. A complete set of Bidding Documents may be acquired by interested bidders on **July 14 – August 3, 2021 (9:00 A.M.)** from given address and website/s below and upon payment of the applicable fee for the Bidding Documents, pursuant to the latest Guidelines issued by the GPPB, in the amount of **Five Thousand Pesos (Php 5,000.00) Only**. The Procuring Entity shall allow the bidder to present its proof of payment for the fees.
6. The CHMSC will hold a **Pre-Bid conference on 10:00 A.M., July 21, 2021 at Bidding Room, 2/F Supply and Property Management Bldg., Brgy. Zone 1, Mabini St., Talisay City, Negros Occidental** and or through video conferencing or webcasting via **Zoom Meeting with ID No. 797 389 7583, Meeting Password 072121**, which shall be open to prospective bidders.
7. Bids must be duly received by the BAC Secretariat through (i) manual submission at the office address as indicated below, (ii) online or electronic submission as indicated below, or (iii) both on or before **9:30 A.M., August 3, 2021**. Late bids shall not be accepted.

Bids may be submitted through electronic mail to bac.sec@chmsc.edu.ph provided that the bidding documents are compressed into two (2) separate archived folders (zip or rar format) and which each folder shall be labelled as “First Envelope_Name of Company_Project Reference Number” and “Second Envelope_Name of Company_Project Reference Number” and each is uniquely password-protected;

Bidders must submit the printed copies (Original, Copy 1 and Copy 2) of their bidding documents within 3 calendar days from bid opening.
8. All Bids must be accompanied by a bid security in any of the acceptable forms and in the amount stated in ITB Clause 16.
9. Bid opening shall be on **10:00 A.M., August 3, 2021** at the **Bidding Room, 2/F Supply and Property Management Bldg., Brgy. Zone 1, Mabini St., Talisay City, Negros Occidental** and/or through **Zoom Meeting ID No. 797 389 7583, Meeting Password 080321**. Bids will be opened in the presence of the bidders’ representatives who choose to attend the activity.
10. The *Carlos Hilado Memorial State College* reserves the right to reject any and all bids, declare a failure of bidding, or not award the contract at any time prior to contract award in accordance with Sections 35.6 and 41 of the 2016 revised Implementing Rules and Regulations (IRR) of RA No. 9184, without thereby incurring any liability to the affected bidder or bidders.
11. For further information, please refer to:
MISS LIGAYA E. FUENTES
Head, BAC Secretariat
Carlos Hilado Memorial State College
Bidding Room, 2/F Supply and Property Management Bldg.
Brgy. Zone 1, Mabini St.,
Talisay City, Negros Occidental
Email Add.: bac.sec@chmsc.edu.ph
Telefax No. (034) 712-8404
Website: chmsc.edu.ph
12. You may visit the following websites:

For downloading of Bidding Documents: chmsc.edu.ph

For online bid submission: bac.sec@chmsc.edu.ph

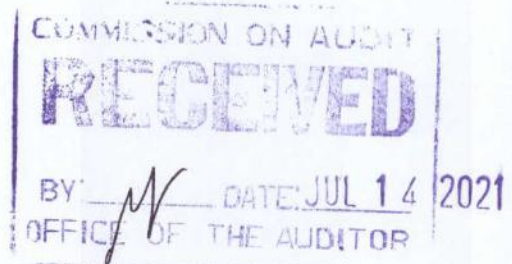

[Signature]
EDWIN H. BUGNA, Ph.D.T.M.
BAC Chairperson

Section II. Instructions to Bidders

Notes on the Instructions to Bidders

This Section on the Instruction to Bidders (ITB) provides the information necessary for bidders to prepare responsive bids, in accordance with the requirements of the Procuring Entity. It also provides information on bid submission, eligibility check, opening and evaluation of bids, post-qualification, and on the award of contract.

1. Scope of Bid

The Procuring Entity, **CARLOS HILADO MEMORIAL STATE COLLEGE** invites Bids for the **UPGRADING OF TVEP BUILDING - PHASE 1 (LABOR AND MATERIALS) - ALIJIS CAMPUS, BRGY. ALIJIS, BACOLOD CITY, NEGROS OCCIDENTAL**, with Project Identification Number **CHMSC 21-035-0713-I**.

The Procurement Project (referred to herein as "Project") is for the construction of Works, as described in Section VI (Specifications).

2. Funding Information

2.1. The GOP through the source of funding as indicated below for 2021 in the amount of **ONE MILLION SEVEN HUNDRED NINETY-NINE THOUSAND NINE HUNDRED SEVENTY-FIVE PESOS & 88/100 (PHP 1,799,975.88) ONLY**.

2.2. The source of funding is:

- a. NGA, the National Expenditure Program.

3. Bidding Requirements

The Bidding for the Project shall be governed by all the provisions of RA No. 9184 and its 2016 revised IRR, including its Generic Procurement Manual and associated policies, rules and regulations as the primary source thereof, while the herein clauses shall serve as the secondary source thereof.

Any amendments made to the IRR and other GPPB issuances shall be applicable only to the ongoing posting, advertisement, or invitation to bid by the BAC through the issuance of a supplemental or bid bulletin.

The Bidder, by the act of submitting its Bid, shall be deemed to have inspected the site, determined the general characteristics of the contracted Works and the conditions for this Project, such as the location and the nature of the work; (b) climatic conditions; (c) transportation facilities; (c) nature and condition of the terrain, geological conditions at the site communication facilities, requirements, location and availability of construction aggregates and other materials, labor, water, electric power and access roads; and (d) other factors that may affect the cost, duration and execution or implementation of the contract, project, or work and examine all instructions, forms, terms, and project requirements in the Bidding Documents.

4. Corrupt, Fraudulent, Collusive, Coercive, and Obstructive Practices

The Procuring Entity, as well as the Bidders and Contractors, shall observe the highest standard of ethics during the procurement and execution of the contract. They or through an agent shall not engage in corrupt, fraudulent, collusive, coercive, and obstructive practices defined under Annex "I" of the 2016 revised IRR of RA No. 9184 or other integrity violations in competing for the Project.

5. Eligible Bidders

5.1. Only Bids of Bidders found to be legally, technically, and financially capable will be evaluated.

5.2. The Bidder must have an experience of having completed a Single Largest Completed Contract (SLCC) that is similar to this Project, equivalent to at least fifty percent (50%) of the ABC adjusted, if necessary, by the Bidder to current prices using the PSA's CPI, except under conditions provided for in Section 23.4.2.4 of the 2016 revised IRR of RA No. 9184.

A contract is considered to be "similar" to the contract to be bid if it has the major categories of work stated in the **BDS**.

5.3. For Foreign-funded Procurement, the Procuring Entity and the foreign government/foreign or international financing institution may agree on another track record requirement, as specified in the Bidding Document prepared for this purpose.

5.4. The Bidders shall comply with the eligibility criteria under Section 23.4.2 of the 2016 IRR of RA No. 9184.

6. Origin of Associated Goods

There is no restriction on the origin of Goods other than those prohibited by a decision of the UN Security Council taken under Chapter VII of the Charter of the UN.

7. Subcontracts

7.1. The Bidder may subcontract portions of the Project to the extent allowed by the Procuring Entity as stated herein, but in no case more than fifty percent (50%) of the Project.

The Procuring Entity has prescribed that:

- a. Subcontracting is allowed. The portions of Project and the maximum percentage allowed to be subcontracted are indicated in the **BDS**, which shall not exceed fifty percent (50%) of the contracted Works.

7.1. The Bidder must submit together with its Bid the documentary requirements of the subcontractor(s) complying with the eligibility criteria stated in **ITB** Clause 5 in accordance with Section 23.4 of the 2016 revised IRR of RA No. 9184 pursuant to Section 23.1 thereof.

- 7.2. The Supplier may identify its subcontractor during the contract implementation stage. Subcontractors identified during the bidding may be changed during the implementation of this Contract. Subcontractors must submit the documentary requirements under Section 23.1 of the 2016 revised IRR of RA No. 9184 and comply with the eligibility criteria specified in **ITB** Clause 5 to the implementing or end-user unit.
- 7.3. Subcontracting of any portion of the Project does not relieve the Contractor of any liability or obligation under the Contract. The Supplier will be responsible for the acts, defaults, and negligence of any subcontractor, its agents, servants, or workmen as fully as if these were the Contractor's own acts, defaults, or negligence, or those of its agents, servants, or workmen.

8. Pre-Bid Conference

The Procuring Entity will hold a pre-bid conference for this Project on the specified date and time and either at its physical address **Bidding Room, 2/F Supply and Property Management Bldg., Brgy. Zone 1, Mabini St., Talisay City, Negros Occidental** or through **Zoom Meeting ID No. 797 389 7583 Meeting Password 072121** as indicated in paragraph 6 of the **IB**.

9. Clarification and Amendment of Bidding Documents

Prospective bidders may request for clarification on and/or interpretation of any part of the Bidding Documents. Such requests must be in writing and received by the Procuring Entity, either at its given address or through electronic mail indicated in the **IB**, at least ten (10) calendar days before the deadline set for the submission and receipt of Bids.

10. Documents Comprising the Bid: Eligibility and Technical Components

- 10.1. The first envelope shall contain the eligibility and technical documents of the Bid as specified in **Section IX. Checklist of Technical and Financial Documents**.
- 10.2. If the eligibility requirements or statements, the bids, and all other documents for submission to the BAC are in foreign language other than English, it must be accompanied by a translation in English, which shall be authenticated by the appropriate Philippine foreign service establishment, post, or the equivalent office having jurisdiction over the foreign bidder's affairs in the Philippines. For Contracting Parties to the Apostille Convention, only the translated documents shall be authenticated through an apostille pursuant to GPPB Resolution No. 13-2019 dated 23 May 2019. The English translation shall govern, for purposes of interpretation of the bid.
- 10.3. A valid PCAB License is required, and in case of joint ventures, a valid special PCAB License, and registration for the type and cost of the contract for this Project. Any additional type of Contractor license or permit shall be indicated in the **BDS**.

- 10.4. A List of Contractor's key personnel (e.g., Project Manager, Project Engineers, Materials Engineers, and Foremen) assigned to the contract to be bid, with their complete qualification and experience data shall be provided. These key personnel must meet the required minimum years of experience set in the **BDS**.
- 10.5. A List of Contractor's major equipment units, which are owned, leased, and/or under purchase agreements, supported by proof of ownership, certification of availability of equipment from the equipment lessor/vendor for the duration of the project, as the case may be, must meet the minimum requirements for the contract set in the **BDS**.

11. Documents Comprising the Bid: Financial Component

- 11.1. The second bid envelope shall contain the financial documents for the Bid as specified in **Section IX. Checklist of Technical and Financial Documents**.
- 11.2. Any bid exceeding the ABC indicated in paragraph 1 of the **IB** shall not be accepted.
- 11.3. For Foreign-funded procurement, a ceiling may be applied to bid prices provided the conditions are met under Section 31.2 of the 2016 revised IRR of RA No. 9184.

12. Alternative Bids

Bidders shall submit offers that comply with the requirements of the Bidding Documents, including the basic technical design as indicated in the drawings and specifications. Unless there is a value engineering clause in the **BDS**, alternative Bids shall not be accepted.

13. Bid Prices

All bid prices for the given scope of work in the Project as awarded shall be considered as fixed prices, and therefore not subject to price escalation during contract implementation, except under extraordinary circumstances as determined by the NEDA and approved by the GPPB pursuant to the revised Guidelines for Contract Price Escalation guidelines.

14. Bid and Payment Currencies

- 14.1. Bid prices may be quoted in the local currency or tradeable currency accepted by the BSP at the discretion of the Bidder. However, for purposes of bid evaluation, Bids denominated in foreign currencies shall be converted to Philippine currency based on the exchange rate as published in the BSP reference rate bulletin on the day of the bid opening.
- 14.2. *Payment of the contract price shall be made in:*

a. Philippine Pesos.

15. Bid Security

- 15.1. The Bidder shall submit a Bid Securing Declaration or any form of Bid Security in the amount indicated in the **BDS**, which shall be not less than the percentage of the ABC in accordance with the schedule in the **BDS**.
- 15.2. The Bid and bid security shall be valid until **December 1, 2021 (120 calendar days upon the date of bid opening)**. Any bid not accompanied by an acceptable bid security shall be rejected by the Procuring Entity as non-responsive.

16. Sealing and Marking of Bids

Each Bidder shall submit one copy of the first and second components of its Bid.

The Procuring Entity may request additional hard copies and/or electronic copies of the Bid. However, failure of the Bidders to comply with the said request shall not be a ground for disqualification.

If the Procuring Entity allows the submission of bids through online submission to the given website or any other electronic means, the Bidder shall submit an electronic copy of its Bid, which must be digitally signed. An electronic copy that cannot be opened or is corrupted shall be considered non-responsive and, thus, automatically disqualified.

17. Deadline for Submission of Bids

The Bidders shall submit on the specified date and time and either at its physical address or through online submission as indicated in paragraph 7 of the **IB**.

18. Opening and Preliminary Examination of Bids

- 18.1. The BAC shall open the Bids in public at the time, on the date, and at the place specified in paragraph 9 of the **IB**. The Bidders' representatives who are present shall sign a register evidencing their attendance. In case videoconferencing, webcasting or other similar technologies will be used, attendance of participants shall likewise be recorded by the BAC Secretariat.

In case the Bids cannot be opened as scheduled due to justifiable reasons, the rescheduling requirements under Section 29 of the 2016 revised IRR of RA No. 9184 shall prevail.

- 18.2. The preliminary examination of Bids shall be governed by Section 30 of the 2016 revised IRR of RA No. 9184.

19. Detailed Evaluation and Comparison of Bids

- 19.1. The Procuring Entity's BAC shall immediately conduct a detailed evaluation of all Bids rated "*passed*" using non-discretionary pass/fail criteria. The BAC

shall consider the conditions in the evaluation of Bids under Section 32.2 of 2016 revised IRR of RA No. 9184.

- 19.2. If the Project allows partial bids, all Bids and combinations of Bids as indicated in the **BDS** shall be received by the same deadline and opened and evaluated simultaneously so as to determine the Bid or combination of Bids offering the lowest calculated cost to the Procuring Entity. Bid Security as required by **ITB** Clause 16 shall be submitted for each contract (lot) separately.
- 19.3. In all cases, the NFCC computation pursuant to Section 23.4.2.6 of the 2016 revised IRR of RA No. 9184 must be sufficient for the total of the ABCs for all the lots participated in by the prospective Bidder.

20. Post Qualification

Within a non-extendible period of five (5) calendar days from receipt by the Bidder of the notice from the BAC that it submitted the Lowest Calculated Bid, the Bidder shall submit its latest income and business tax returns filed and paid through the BIR Electronic Filing and Payment System (eFPS), and other appropriate licenses and permits required by law and stated in the **BDS**.

21. Signing of the Contract

The documents required in Section 37.2 of the 2016 revised IRR of RA No. 9184 shall form part of the Contract. Additional Contract documents are indicated in the **BDS**.

Section III. Bid Data Sheet

Notes on the Bid Data Sheet (BDS)

The Bid Data Sheet (BDS) consists of provisions that supplement, amend, or specify in detail, information, or requirements included in the ITB found in Section II, which are specific to each procurement.

This Section is intended to assist the Procuring Entity in providing the specific information in relation to corresponding clauses in the ITB and has to be prepared for each specific procurement.

The Procuring Entity should specify in the BDS information and requirements specific to the circumstances of the Procuring Entity, the processing of the procurement, and the bid evaluation criteria that will apply to the Bids. In preparing the BDS, the following aspects should be checked:

- a. Information that specifies and complements provisions of the ITB must be incorporated.
- b. Amendments and/or supplements, if any, to provisions of the ITB as necessitated by the circumstances of the specific procurement, must also be incorporated.

Bid Data Sheet

ITB Clause																												
5.2	<p>For this purpose, contracts similar to the Project refer to contracts which have the same major categories of work, which shall be:</p> <p style="margin-left: 40px;">1. <i>Renovations Works</i></p>																											
7.1	<p><i>[Specify the portions of Works and the maximum percentage allowed to be subcontracted, which shall not be significant or material components of the Project as determined by the Procuring Entity.]</i></p> <p>“Subcontracting is allowed.”</p> <p>The following works may be subcontracted:</p> <p style="margin-left: 40px;">1. Electrical Works</p>																											
10.3	<p>PCAB Registration/PCAB License</p> <p>Small B (up to 30M).</p>																											
10.4	<p>The minimum work experience requirements for Construction key personnel are the following:</p> <table border="1" style="width: 100%; border-collapse: collapse; margin-left: 40px;"> <thead> <tr> <th style="width: 30%;">Key Personnel</th> <th style="width: 40%;">General Experience</th> <th style="width: 30%;">Relevant Experience (years)</th> </tr> </thead> <tbody> <tr> <td colspan="3">Daily required site personnel</td> </tr> <tr> <td>1. Project Engineer</td> <td>Registered Civil Engineer</td> <td style="text-align: center;">5</td> </tr> <tr> <td>2. Foreman</td> <td>High School Graduate</td> <td style="text-align: center;">5</td> </tr> <tr> <td>3. Construction Safety and Health Personnel</td> <td>With HSE/COSH Training</td> <td style="text-align: center;">5</td> </tr> </tbody> </table>	Key Personnel	General Experience	Relevant Experience (years)	Daily required site personnel			1. Project Engineer	Registered Civil Engineer	5	2. Foreman	High School Graduate	5	3. Construction Safety and Health Personnel	With HSE/COSH Training	5												
Key Personnel	General Experience	Relevant Experience (years)																										
Daily required site personnel																												
1. Project Engineer	Registered Civil Engineer	5																										
2. Foreman	High School Graduate	5																										
3. Construction Safety and Health Personnel	With HSE/COSH Training	5																										
10.5	<p>The minimum major equipment requirements are the following:</p> <table border="1" style="width: 100%; border-collapse: collapse; margin-left: 40px;"> <thead> <tr> <th style="width: 50%;"><u>Equipment</u></th> <th style="width: 20%;"><u>Capacity</u></th> <th style="width: 30%;"><u>Number of Units</u></th> </tr> </thead> <tbody> <tr> <td>Hand Tools and Power Tools</td> <td></td> <td style="text-align: center;">5</td> </tr> <tr> <td>Service Vehicle</td> <td></td> <td style="text-align: center;">1</td> </tr> <tr> <td>Welding Machine</td> <td></td> <td style="text-align: center;">2</td> </tr> <tr> <td>One Bagger Mixer</td> <td></td> <td style="text-align: center;">2</td> </tr> <tr> <td>Concrete Vibrator</td> <td></td> <td style="text-align: center;">3</td> </tr> <tr> <td>Bar Cutter</td> <td></td> <td style="text-align: center;">1</td> </tr> <tr> <td>Bar Bender</td> <td></td> <td style="text-align: center;">1</td> </tr> <tr> <td>Chain Block</td> <td></td> <td style="text-align: center;">1</td> </tr> </tbody> </table>	<u>Equipment</u>	<u>Capacity</u>	<u>Number of Units</u>	Hand Tools and Power Tools		5	Service Vehicle		1	Welding Machine		2	One Bagger Mixer		2	Concrete Vibrator		3	Bar Cutter		1	Bar Bender		1	Chain Block		1
<u>Equipment</u>	<u>Capacity</u>	<u>Number of Units</u>																										
Hand Tools and Power Tools		5																										
Service Vehicle		1																										
Welding Machine		2																										
One Bagger Mixer		2																										
Concrete Vibrator		3																										
Bar Cutter		1																										
Bar Bender		1																										
Chain Block		1																										
12	<p><i>[Insert Value Engineering clause if allowed.]</i></p> <p>The Approved Budget for the Contract (ABC) is ONE MILLION SEVEN HUNDRED NINETY NINE THOUSAND NINE HUNDRED SEVENTY FIVE PESOS & 88/100 (PhP 1,799,975.88) ONLY.</p> <p>Any bid with a financial component exceeding this amount shall not be accepted.</p>																											
15.1	<p>The bid security shall be in the form of a Bid Securing Declaration or any of the following forms and amounts:</p>																											

	<ol style="list-style-type: none"> 1. The amount of not less than PhP 35,999.52 (2% of ABC), if bid security is in cash, cashier's/manager's check, bank draft/guarantee or irrevocable letter of credit; 2. The amount of not less than PhP 89,998.79 (5% of ABC) if bid security is in Surety Bond.
19.2	Partial bids are not allowed
20	<i>No further instructions</i>
21	<p>Additional contract documents relevant to the Project:</p> <ol style="list-style-type: none"> 1) Construction Schedule/GANTT Chart (MS Project Format) & S-curve 2) Manpower Schedule 3) Construction Methods 4) Equipment Utilization Schedule 5) Construction Safety and Health Program (approved by the DOLE) 6) PERT/CPM 7) Statement of Cash Flow & Payment Schedule 8) Soft Copy of all submitted documents in PDF File (submit in CD) 9) Organizational Chart

Section IV. General Conditions of Contract

Notes on the General Conditions of Contract

The General Conditions of Contract (GCC) in this Section, read in conjunction with the Special Conditions of Contract in Section V and other documents listed therein, should be a complete document expressing all the rights and obligations of the parties.

Matters governing performance of the Contractor, payments under the contract, or matters affecting the risks, rights, and obligations of the parties under the contract are included in the GCC and Special Conditions of Contract.

Any complementary information, which may be needed, shall be introduced only through the Special Conditions of Contract.

1. Scope of Contract

This Contract shall include all such items, although not specifically mentioned, that can be reasonably inferred as being required for its completion as if such items were expressly mentioned herein. All the provisions of RA No. 9184 and its 2016 revised IRR, including the Generic Procurement Manual, and associated issuances, constitute the primary source for the terms and conditions of the Contract, and thus, applicable in contract implementation. Herein clauses shall serve as the secondary source for the terms and conditions of the Contract.

This is without prejudice to Sections 74.1 and 74.2 of the 2016 revised IRR of RA No. 9184 allowing the GPPB to amend the IRR, which shall be applied to all procurement activities, the advertisement, posting, or invitation of which were issued after the effectivity of the said amendment.

2. Sectional Completion of Works

If sectional completion is specified in the **Special Conditions of Contract (SCC)**, references in the Conditions of Contract to the Works, the Completion Date, and the Intended Completion Date shall apply to any Section of the Works (other than references to the Completion Date and Intended Completion Date for the whole of the Works).

3. Possession of Site

- 4.1. The Procuring Entity shall give possession of all or parts of the Site to the Contractor based on the schedule of delivery indicated in the **SCC**, which corresponds to the execution of the Works. If the Contractor suffers delay or incurs cost from failure on the part of the Procuring Entity to give possession in accordance with the terms of this clause, the Procuring Entity's Representative shall give the Contractor a Contract Time Extension and certify such sum as fair to cover the cost incurred, which sum shall be paid by Procuring Entity.
- 4.2. If possession of a portion is not given by the above date, the Procuring Entity will be deemed to have delayed the start of the relevant activities. The resulting adjustments in contract time to address such delay may be addressed through contract extension provided under Annex "E" of the 2016 revised IRR of RA No. 9184.

4. The Contractor's Obligations

The Contractor shall employ the key personnel named in the Schedule of Key Personnel indicating their designation, in accordance with **ITB Clause 10.3** and specified in the **BDS**, to carry out the supervision of the Works.

The Procuring Entity will approve any proposed replacement of key personnel only if their relevant qualifications and abilities are equal to or better than those of the personnel listed in the Schedule.

5. Performance Security

- 5.1. Within ten (10) calendar days from receipt of the Notice of Award from the Procuring Entity but in no case later than the signing of the contract by both parties, the successful Bidder shall furnish the performance security in any of the forms prescribed in Section 39 of the 2016 revised IRR.
- 5.2. The Contractor, by entering into the Contract with the Procuring Entity, acknowledges the right of the Procuring Entity to institute action pursuant to RA No. 3688 against any subcontractor be they an individual, firm, partnership, corporation, or association supplying the Contractor with labor, materials and/or equipment for the performance of this Contract.

6. Site Investigation Reports

The Contractor, in preparing the Bid, shall rely on any Site Investigation Reports referred to in the SCC supplemented by any information obtained by the Contractor.

7. Warranty

- 7.1. In case the Contractor fails to undertake the repair works under Section 62.2.2 of the 2016 revised IRR, the Procuring Entity shall forfeit its performance security, subject its property(ies) to attachment or garnishment proceedings, and perpetually disqualify it from participating in any public bidding. All payables of the GOP in his favor shall be offset to recover the costs.
- 7.2. The warranty against Structural Defects/Failures, except that occasioned-on force majeure, shall cover the period from the date of issuance of the Certificate of Final Acceptance by the Procuring Entity. Specific duration of the warranty is found in the SCC.

8. Liability of the Contractor

Subject to additional provisions, if any, set forth in the SCC, the Contractor's liability under this Contract shall be as provided by the laws of the Republic of the Philippines. If the Contractor is a joint venture, all partners to the joint venture shall be jointly and severally liable to the Procuring Entity.

9. Termination for Other Causes

Contract termination shall be initiated in case it is determined *prima facie* by the Procuring Entity that the Contractor has engaged, before, or during the implementation of the contract, in unlawful deeds and behaviors relative to contract acquisition and implementation, such as, but not limited to corrupt, fraudulent, collusive, coercive, and obstructive practices as stated in **ITB** Clause 4.

10. Dayworks

Subject to the guidelines on Variation Order in Annex "E" of the 2016 revised IRR of RA No. 9184, and if applicable as indicated in the SCC, the Dayworks rates in the Contractor's Bid shall be used for small additional amounts of work only when the Procuring Entity's Representative has given written instructions in advance for additional work to be paid for in that way.

11. Program of Work

11.1. The Contractor shall submit to the Procuring Entity's Representative for approval the said Program of Work showing the general methods, arrangements, order, and timing for all the activities in the Works. The submissions of the Program of Work are indicated in the SCC.

11.2. The Contractor shall submit to the Procuring Entity's Representative for approval an updated Program of Work at intervals no longer than the period stated in the SCC. If the Contractor does not submit an updated Program of Work within this period, the Procuring Entity's Representative may withhold the amount stated in the SCC from the next payment certificate and continue to withhold this amount until the next payment after the date on which the overdue Program of Work has been submitted.

12. Instructions, Inspections and Audits

The Contractor shall permit the GOP or the Procuring Entity to inspect the Contractor's accounts and records relating to the performance of the Contractor and to have them audited by auditors of the GOP or the Procuring Entity, as may be required.

13. Advance Payment

The Procuring Entity shall, upon a written request of the Contractor which shall be submitted as a Contract document, make an advance payment to the Contractor in an amount not exceeding fifteen percent (15%) of the total contract price, to be made in lump sum, or at the most two installments according to a schedule specified in the SCC, subject to the requirements in Annex "E" of the 2016 revised IRR of RA No. 9184.

14. Progress Payments

The Contractor may submit a request for payment for Work accomplished. Such requests for payment shall be verified and certified by the Procuring Entity's Representative/Project Engineer. Except as otherwise stipulated in the SCC, materials and equipment delivered on the site but not completely put in place shall not be included for payment.

15. Operating and Maintenance Manuals

15.1. If required, the Contractor will provide "as built" Drawings and/or operating and maintenance manuals as specified in the SCC.

- 15.2. If the Contractor does not provide the Drawings and/or manuals by the dates stated above, or they do not receive the Procuring Entity's Representative's approval, the Procuring Entity's Representative may withhold the amount stated in the SCC from payments due to the Contractor.

Section V. Special Conditions of Contract

Notes on the Special Conditions of Contract

Similar to the BDS, the clauses in this Section are intended to assist the Procuring Entity in providing contract-specific information in relation to corresponding clauses in the GCC found in Section IV.

The Special Conditions of Contract (SCC) complement the GCC, specifying contractual requirements linked to the special circumstances of the Procuring Entity, the Procuring Entity's country, the sector, and the Works procured. In preparing this Section, the following aspects should be checked:

- a. Information that complements provisions of the GCC must be incorporated.
- b. Amendments and/or supplements to provisions of the GCC as necessitated by the circumstances of the specific purchase, must also be incorporated.

However, no special condition which defeats or negates the general intent and purpose of the provisions of the GCC should be incorporated herein.

Special Conditions of Contract

GCC Clause	
2	<p>The Intended Completion Date is</p> <p>90 calendar days upon receipt of the Notice to Proceed</p> <p><i>NOTE: The contract duration shall be reckoned from the start date and not from contract effectivity date.</i></p>
4.1	The CHMSC shall give possession of all parts of the Site to the Contractor upon receipt of Notice to Proceed by the latter.
6	<p>The site investigation reports are:</p> <p><i>No further instructions</i></p>
7.2	<p><i>In case of permanent structures, such as buildings of types 4 and 5 as classified under the National Building Code of the Philippines and other structures made of steel, iron, or concrete which comply with relevant structural codes (e.g., DPWH Standard Specifications), such as, but not limited to, steel/concrete bridges, flyovers, aircraft movement areas, ports, dams, tunnels, filtration and treatment plants, sewerage systems, power plants, transmission and communication towers, railway system, and other similar permanent structures: Fifteen (15) years.</i></p>
10	a. No dayworks are applicable to the contract.
11.1	The Contractor shall submit the Program of Work to the Procuring Entity's Representative within 15 days of delivery of the Notice of Award.
11.2	<p>The period of Program of Work updates is every fifteen (15) days.</p> <p>The amount to be withheld for late submission of an updated Program of Work is FIFTEEN THOUSAND PESOS (Php15,000.00) only. Other relevant rules and regulations as well as communication protocol shall be discussed during the pre-bid conference and shall form part of the contract. Copy of which given to the contractor on the date for the conduct of the pre-construction conference.</p>
13	<p>The amount of the advance payment is</p> <p>8% - upon the submission to and acceptance by the procuring entity of an irrevocable standby letter of credit of equivalent value from a commercial bank, a bank guarantee or a surety bond callable upon demand, issued by a surety or insurance company duly licensed by the Insurance Commission and confirmed by the procuring entity.</p> <p>7% - After submission to procuring entity the documents as proof of mobilization.</p> <p>The full mobilization fund shall be recouped from the regular billing of the contractor up to and until 50% of the contract amount are paid to the contractor.</p>
14	Equipment delivered on the site but not completely put in place shall be included for payment.

	Storage of equipment shall be contractor's responsibility. Equipment shall be covered by the defects liability period of one year from the date of final handing over.
15.1	<p>The date by which operating and maintenance manuals are required during the commissioning of each of the equipment to be installed by the contractor.</p> <p>The date by which "as built" drawings are required will be before the processing of the occupancy permit or fifteen (15) calendar days from the final handing over whichever comes earlier.</p>
15.2	The amount to be withheld for failing to produce "as built" drawings and/or operating and maintenance manuals by the date required is TWENTY-FIVE THOUSAND PESOS (Php25,000.00) ONLY for each requirement.

THIS LOCATION AT THE TVEP BUILDING

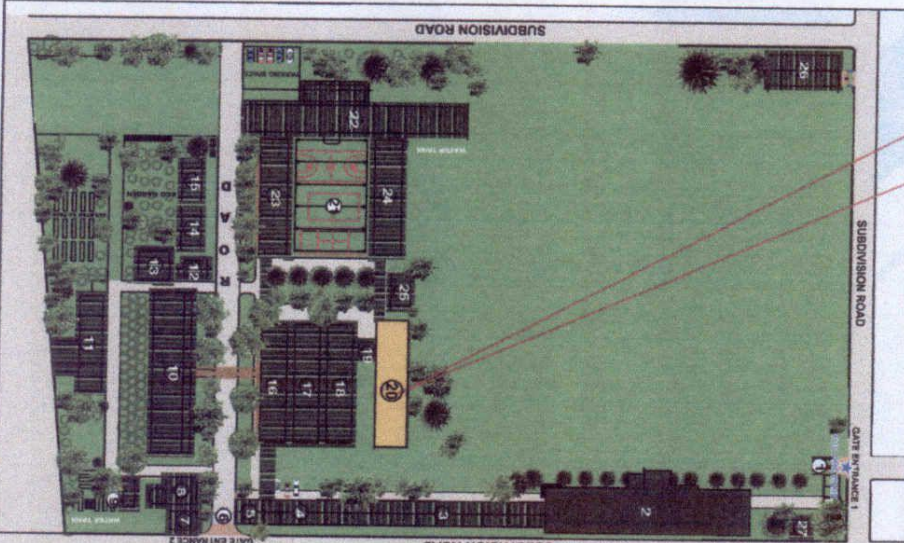

BUILDING DIRECTORY

1. ALLIS CAMPUS NORTH GATE 1
2. SCIENCE AND TECHNOLOGY BUILDING
3. THREE STOREY LABORATORY BUILDING
4. COMPUTER TECHNOLOGY BUILDING
CANTEN (GROUND FLOOR)
COMP TECH. BUILDING (SECOND FLOOR)
P.E. ROOM (ROOF DECK THIRD FLOOR)
5. GUARD HOUSE
6. GATE 2
7. OLD CANTEEN
8. STOCKROOM
9. ECO PARK
10. ACADEMIC BUILDING 3
11. PROPOSE MALE DORMITORY
12. PTA OFFICE
13. ALUMNI BUILDING
14. MULT-MEDIA BUILDING 1
15. MULT-MEDIA BUILDING 2
16. MECHANICAL TECHNOLOGY BUILDING
17. AUTOMOTIVE SERVICE CENTER
18. AUTOMOTIVE TECHNOLOGY BUILDING
19. PTA HALL
20. TVEP BUILDING
21. COVERED COURT
22. ADMIN OFFICE/ CASHIER/ LIBRARY/
REGISTRAR/ OSA OFFICE
23. ACADEMIC BUILDING 1
24. ACADEMIC BUILDING 2
25. CAMPUS TOILET AND BATH
26. MRF BUILDING
27. POWER HOUSE

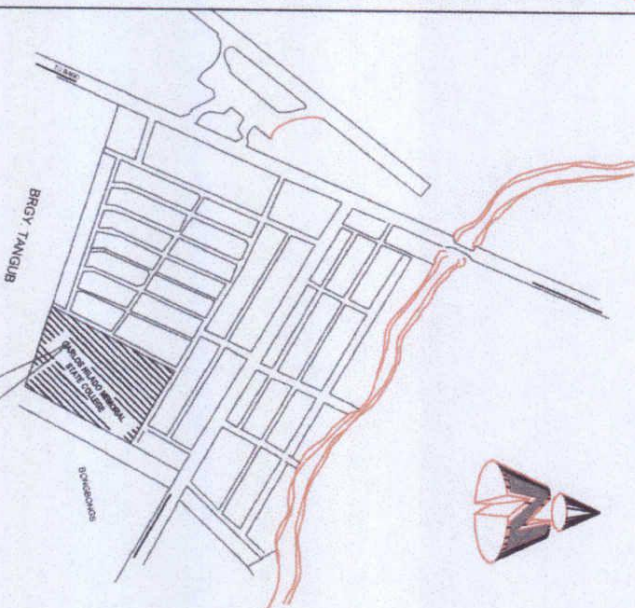

VICINITY MAP



Republic of the Philippines
CARLOS HILADO MEMORIAL
STATE COLLEGE
May 29, Occidental

PROJECT TITLE: UPGRADING TVEP BUILDING PHASE-1	ENDORSED BY: 	CHECKED BY: 	RECOMMENDING APPROVAL: 	APPROVED: 	PREPARED / CHECKED BY: FEDERICO V. DENISA, JR., Ph.D. CAMPUS EXECUTIVE OFFICER / REGISTRAR L. BELARRINO CAMPUS EXECUTIVE	PROJECT NO. A 1
PROJECT LOCATION: ALLIS CAMPUS, BAGUO, CO. CITY	CAMPUS DIRECTOR: EDWIN H. BURGOS, Ph.D.	DIRECTOR PRRM: EDNA MAN-LIN MARQUIZE	VICE PRESIDENT FOR ADMINISTRATION: MRS. ROSALINDA S. TANHULA	SUC PRESIDENT III: NORBERTO P. MANGOUL-BRIAL, Ph.D.		



Republic of the Philippines
CARLOS HILADO MEMORIAL
 STATE COLLEGE
 Higher Education

PROJECT TITLE:
 UPGRADING TYPE BUILDING
 PHASE - 1

ENDORSED BY:
 EDWIN H. BUONIA, Ph.D.
 CAMPUS DIRECTOR

CHECKED BY:
 ENRIQUE J. MANGROQUE
 DIRECTOR FROM

RECOMMENDING APPROVAL:
 MRS. ROSALINDA S. TUVALA
 VICE PRESIDENT FOR ADMINISTRATION

APPROVED:
 NORBERTO P. MARQUEZ, Ph.D.
 VICE PRESIDENT

PREPARED / CHECKED BY:
 FEDERICO V. DENISA, JR., Ph.D.
 L. BELARMINO
 CAMPUS DESIGN ARCHITECTS
 CAMPUS DESIGN

DATE:
 A 2

FIRST FLOOR PLAN

SCALE
 1:100

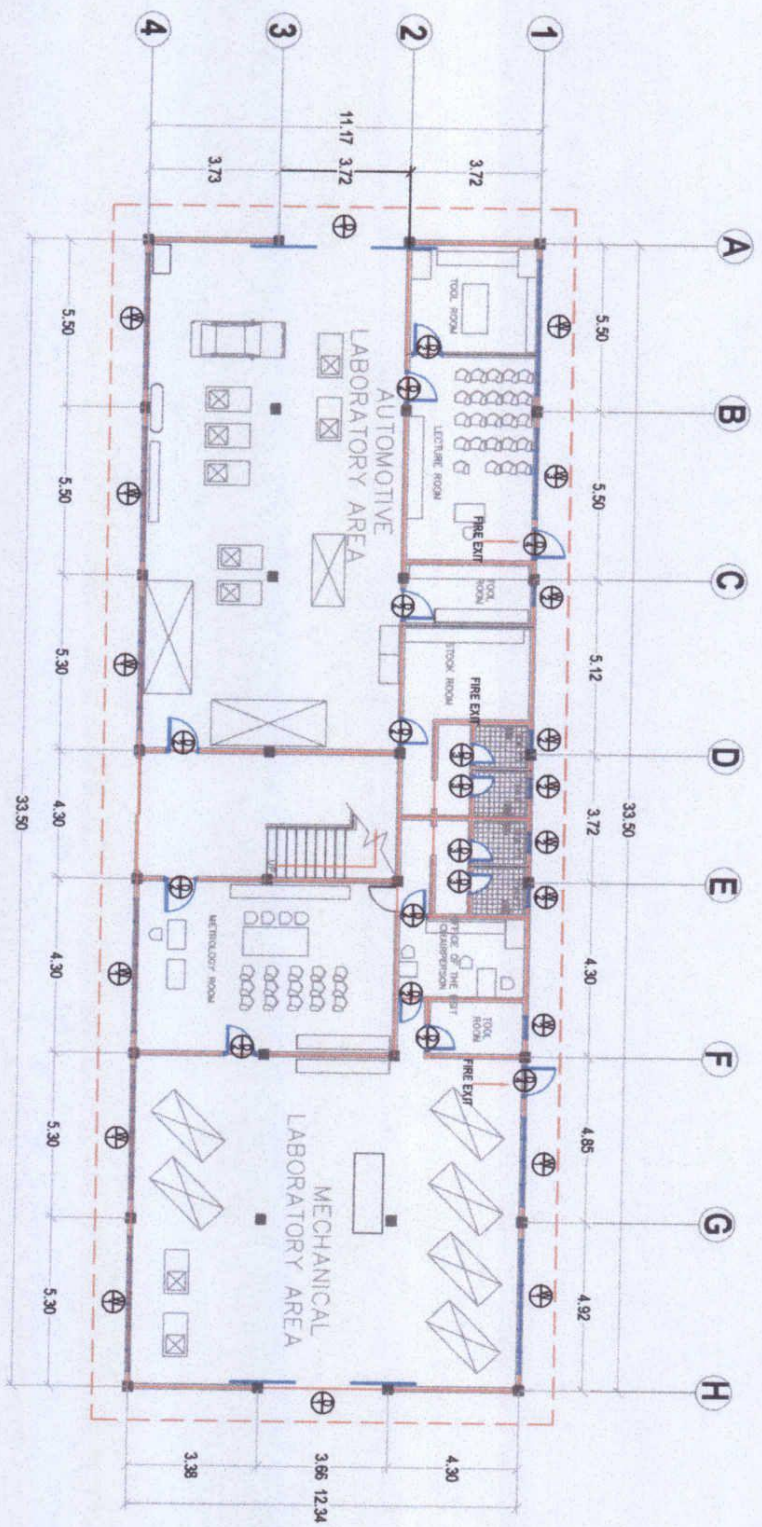



Republic of the Philippines
**CARLOS HILADO MEMORIAL
 STATE COLLEGE**
 Negros Occidental

PROJECT TITLE:
 UPGRADING TYER BUILDING
 PHASE - 1

ENDORSED BY:
 EDWIN H. BUONA, Ph.D.
 CAMPUS DIRECTOR

CHECKED BY:
 DIRECTOR PPOB

RECOMMENDING APPROVAL:
 MRS. ROSALINDA S. TANILLA
 VICE PRESIDENT FOR ADMINISTRATION

APPROVED:
 NORBERTO P. AMANOU/BUENA, Ph.D.
 SUC PRESIDENT

PREPARED / CHECKED BY:
 FEDERICO V. DENISA, JR., Ph.D.
 L. BELLAHINO
 CAMPUS DRAFTSMAN

SHEET NO. 1
3

PROJECT LOCATION:
 ALIUS CARRING, BACOLOD CITY

SECOND FLOOR PLAN
 SCALE 1:100

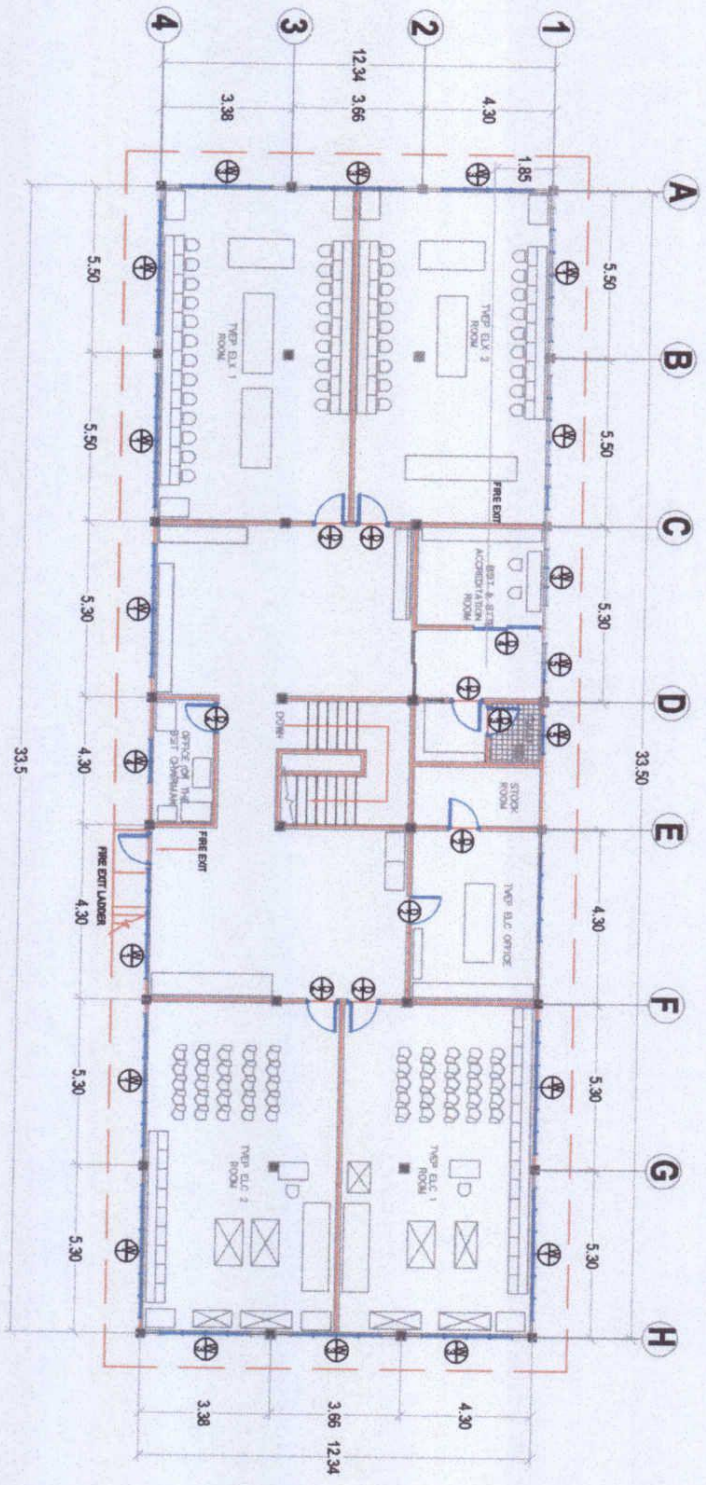



Republic of the Philippines
**CARLOS HILADO MEMORIAL
 STATE COLLEGE**
 Negros Occidental

PROJECT TITLE:
 UPGRADING TYPE BUILDING
 PHASE-1

ENDORSED BY:
 EDWIN H. BUONIA, Ph.D.
 CAMPUS DIRECTOR

CHECKED BY:
 DIRECTOR P/PRO

RECOMMENDING APPROVAL:
 VICE PRESIDENT FOR ADMINISTRATION

APPROVED:
 VIC PRESIDENT III

PREPARED/CHECKED BY:
 L. BELARMINO
 CAMPUS ENGINEER

DATE: 11/11/2017
 SHEET NO. 4

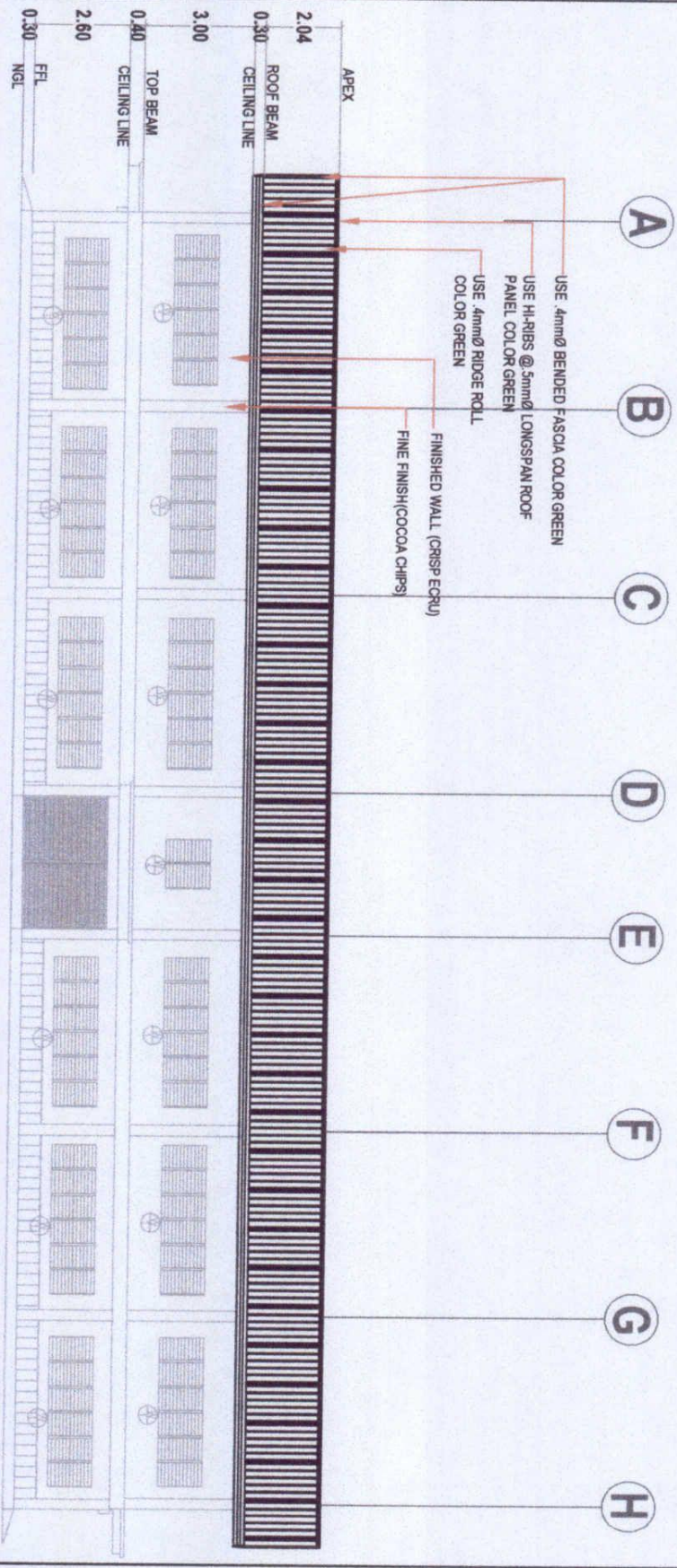

FRONT VIEW ELEVATION
 SCALE 1:100



Republic of the Philippines
**CARLOS HILADO MEMORIAL
 STATE COLLEGE**
 Negros Occidental

PROJECT TITLE: UPGRADING TYPE BUILDING PHASE-1	ENDORSED BY: 	CHECKED BY: 	RECOMMENDING APPROVAL: 	APPROVED: 	PREPARED / CHECKED BY:
PROJECT LOCATION: ALIBIS CAMPUS, BACOLOD CITY	EDWIN H. BIRONA, Ph.D. CAMPUS DIRECTOR	EDGARDO L. MANRIQUEZ DIRECTOR OF P&E	MRS. ROSALINDA S. TUVILLA VICE PRESIDENT FOR ADMINISTRATION	NORBERTO P. MANALIGAYAN, Ph.D. SIC PRESIDENT III	FEDERICO V. DEBUCA, JR., Ph.D. CAMPUS ENGINEER, PLANT AND FACILITIES
					A 5

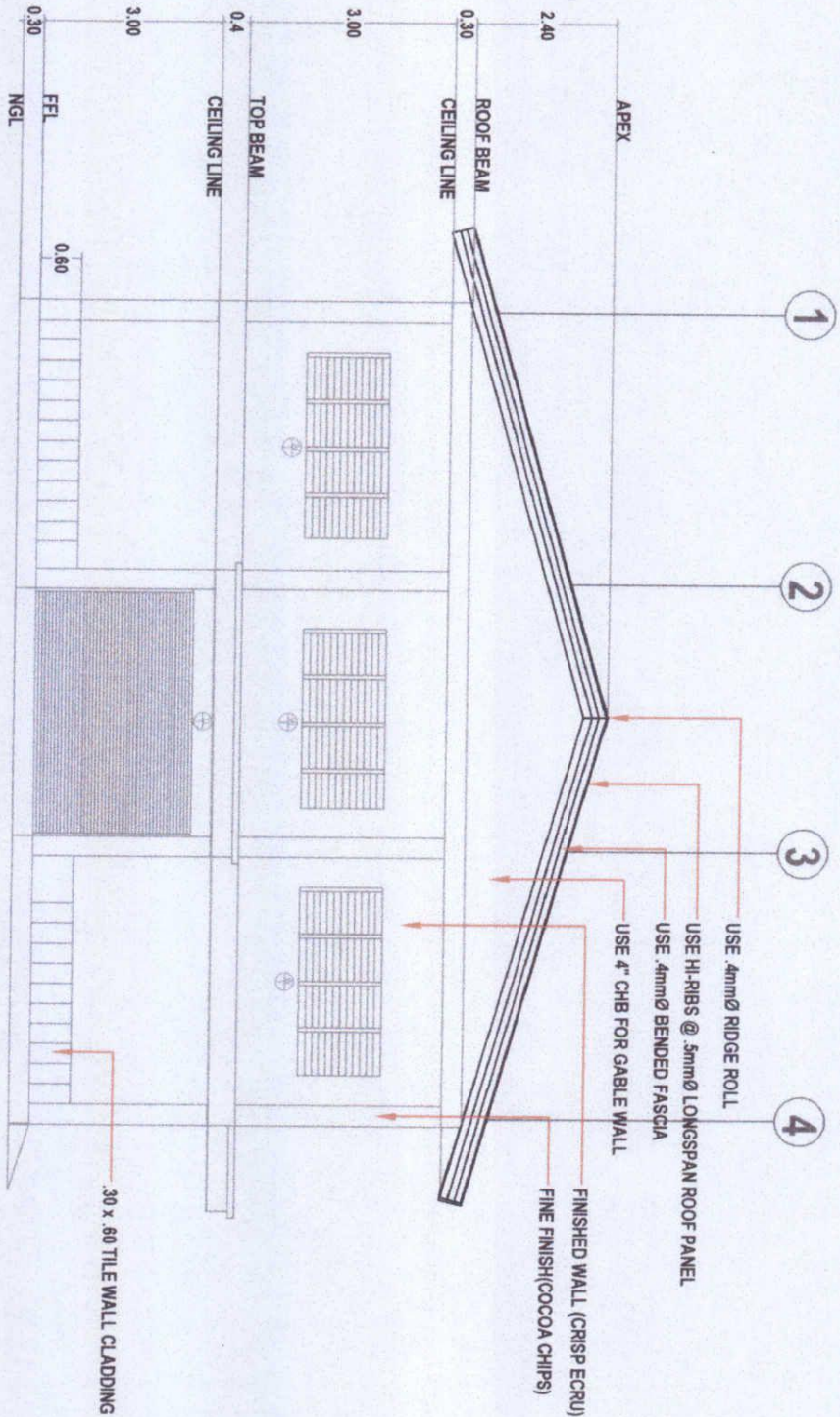

LEFT VIEW ELEVATION
 SCALE 1:100

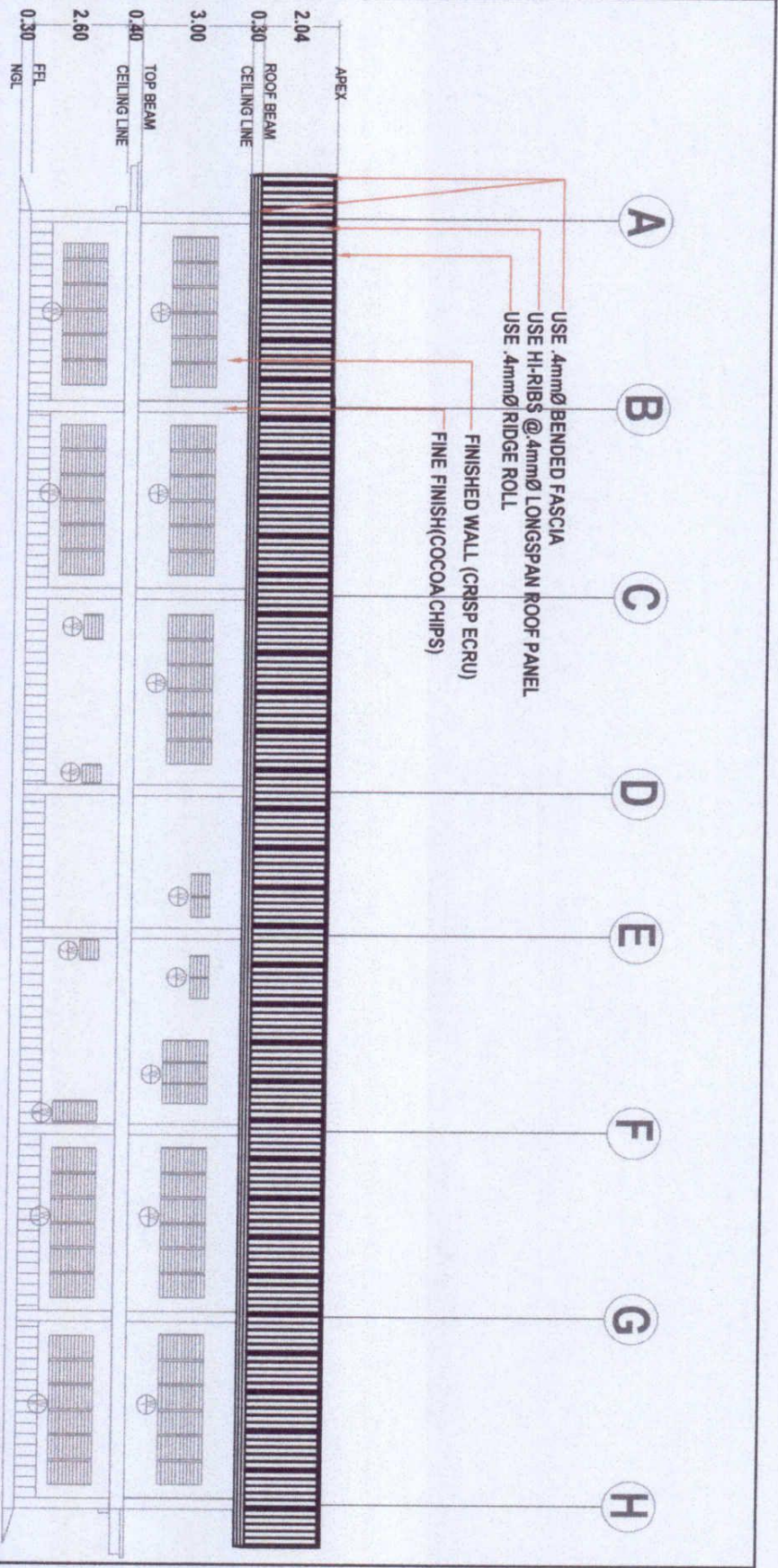

REAR VIEW ELEVATION
 SCALE 1:80

	Republic of the Philippines CARLOS HILADO MEMORIAL STATE COLLEGE <small>Negros Occidental</small>	PROJECT TITLE: UPGRADING TYPE BUILDING PHASE-1	ENDORSED BY:  <small>EDWIN H. BARDON, Ph.D.</small> <small>CAMPUS DIRECTOR</small>	CHECKED BY:  <small>EDUARDO LIM MASARAGA</small> <small>DIRECTOR FOR</small>	RECOMMENDING APPROVAL:  <small>MRS. JOCELYN A. PINEDA</small> <small>VICE PRESIDENT FOR ADMINISTRATION</small>	APPROVED:  <small>NORBERTO P. MANGOULAYAN, Ph.D.</small> <small>SIC PRESIDENT III</small>	PREPARED / CHECKED BY:  <small>FEDERICO V. DENSA, JR. Ph.D.</small> <small>CAMPUS DEVELOPMENT PLANNING AND ACQUISITION</small> <small>L. BELARMINO</small> <small>CAMPUS DEVELOPER</small>	SHEET NO. PROJECT NO. A 6
---	--	--	--	--	--	---	--	-------------------------------------



Republic of the Philippines
CARLOS TILADO MEMORIAL
STATE COLLEGE
Maguindanao

PROJECT TITLE: UPGRADING TYPE BUILDING PHASE-1	ENDORSED BY: 	CHECKED BY: 	RECOMMENDING APPROVAL: 	APPROVED: 	PREPARED, CHECKED BY: 	DATE: _____
PROJECT LOCATION: ALIBIS CAMPUS, BACOLOD CITY	EDWIN H. BUONA, PH.D. CAMPUS DIRECTOR	ENGR. JUN-JUN MARQUEZ DIRECTOR PROJ.	MRS. ROSALINDA VILLULA VICE PRESIDENT FOR ADMINISTRATION	NORBERTO P. MANDULABNAN, PH.D. VICE PRESIDENT III	ENGR. REYNOLDY BERNA, JR. PH.D. CHIEF ENGINEER	
						A 7

RIGHT VIEW ELEVATION

SCALE 1:100

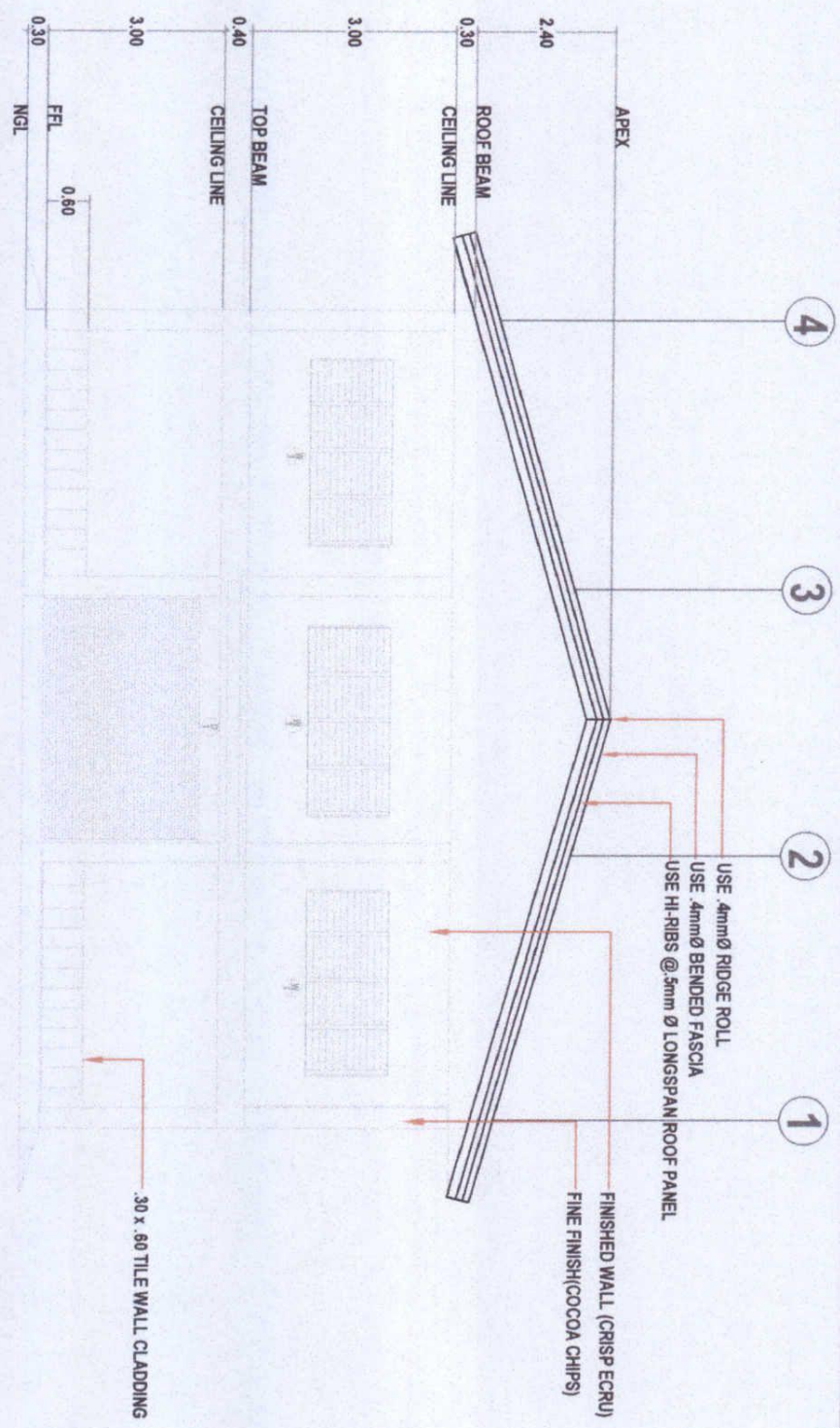



Republic of the Philippines
CARLOS HILADO MEMORIAL STATE COLLEGE
 Higher Education

PROJECT TITLE:
 UPGRADING TIER BUILDING PHASE-1

ENDORSED BY:
 EDWIN H. BUQUIA, Ph.D.
 CAMPUS DIRECTOR

CHECKED BY:
 MR. JUAN M. ...
 CHIEF ARCHITECT

RECOMMENDING APPROVAL:
 MRS. ROSALINDA S. ...
 VICE PRESIDENT FOR ADMINISTRATION

APPROVED:
 ROBERTO P. ...
 VICE PRESIDENT

PREPARED / CHECKED BY:
 ...
 L. BELTRANINO
 CHIEF ARCHITECT

Sheet No. 1 of 1

ROOF FRAMING PLAN

SCALE: 1:100

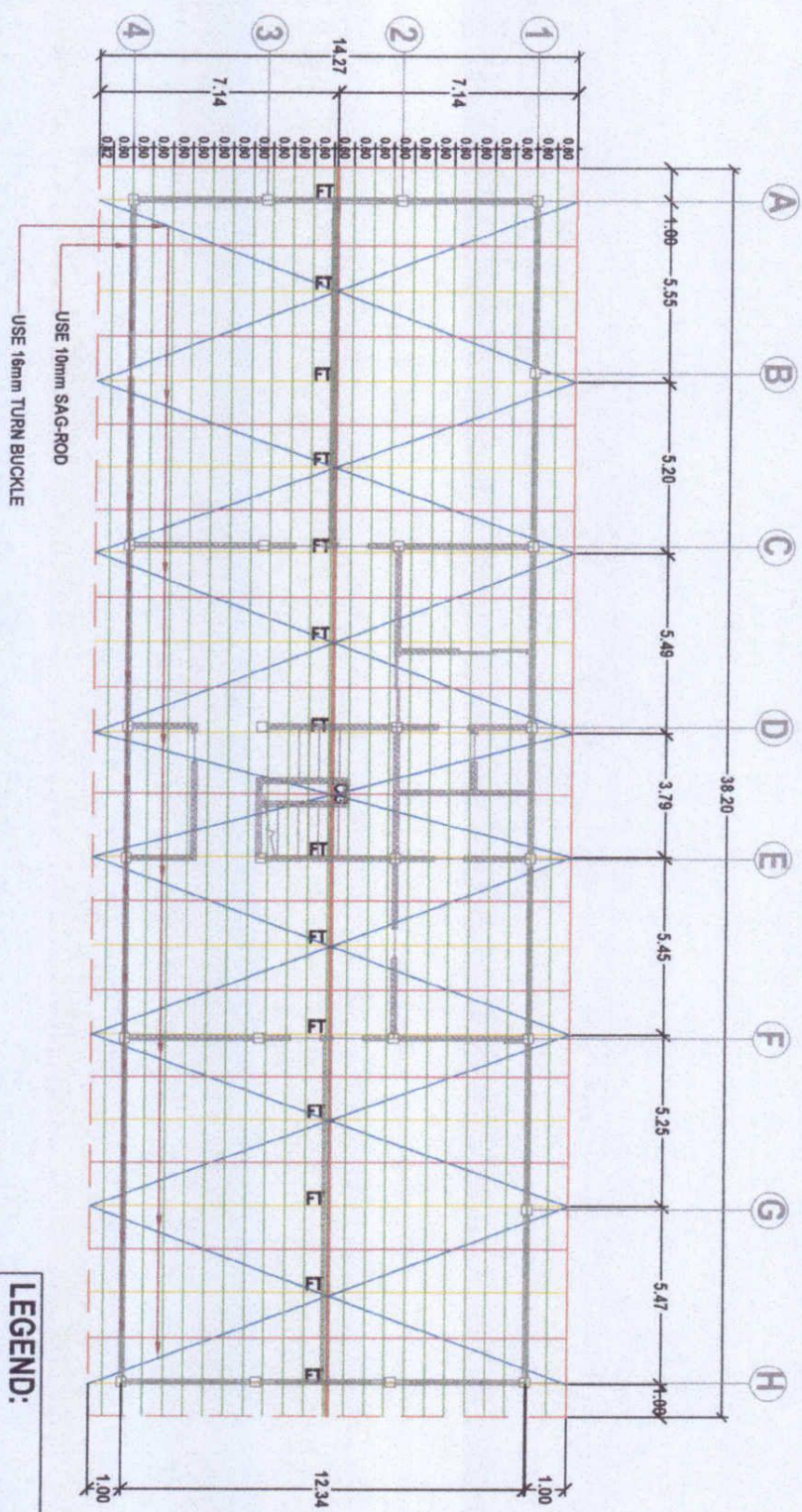

LEGEND:

- ROOF FRAME
- FULL TRUSS
- CENTER GIRT
- BATTENS
- TURN BUCKLE
- SAG-ROD



PROJECT TITLE: UPGRADING TVEP BUILDING PHASE-1		ENFORCED BY: EDWIN H. BUDUA, PH.D. CAMPUS DIRECTOR		CHECKED BY: ANG DAN-JUN MARABUZ DIRECTOR PROB		RECOMMENDING APPROVAL: MRS. ROSALINDA S. TAVA VICE PRESIDENT FOR ADMINISTRATION		APPROVED: NORBERTO P. MANOUAL, PH.D. SUC PRESIDENT III		PREPARED / CHECKED BY: L. BELARMINO CAMPUS DEVELOPER	
PROJECT LOCATION: ALUBI CAMPUS, MACOLONG CITY										SHEET NO. OF TOTAL SHEETS S 2	

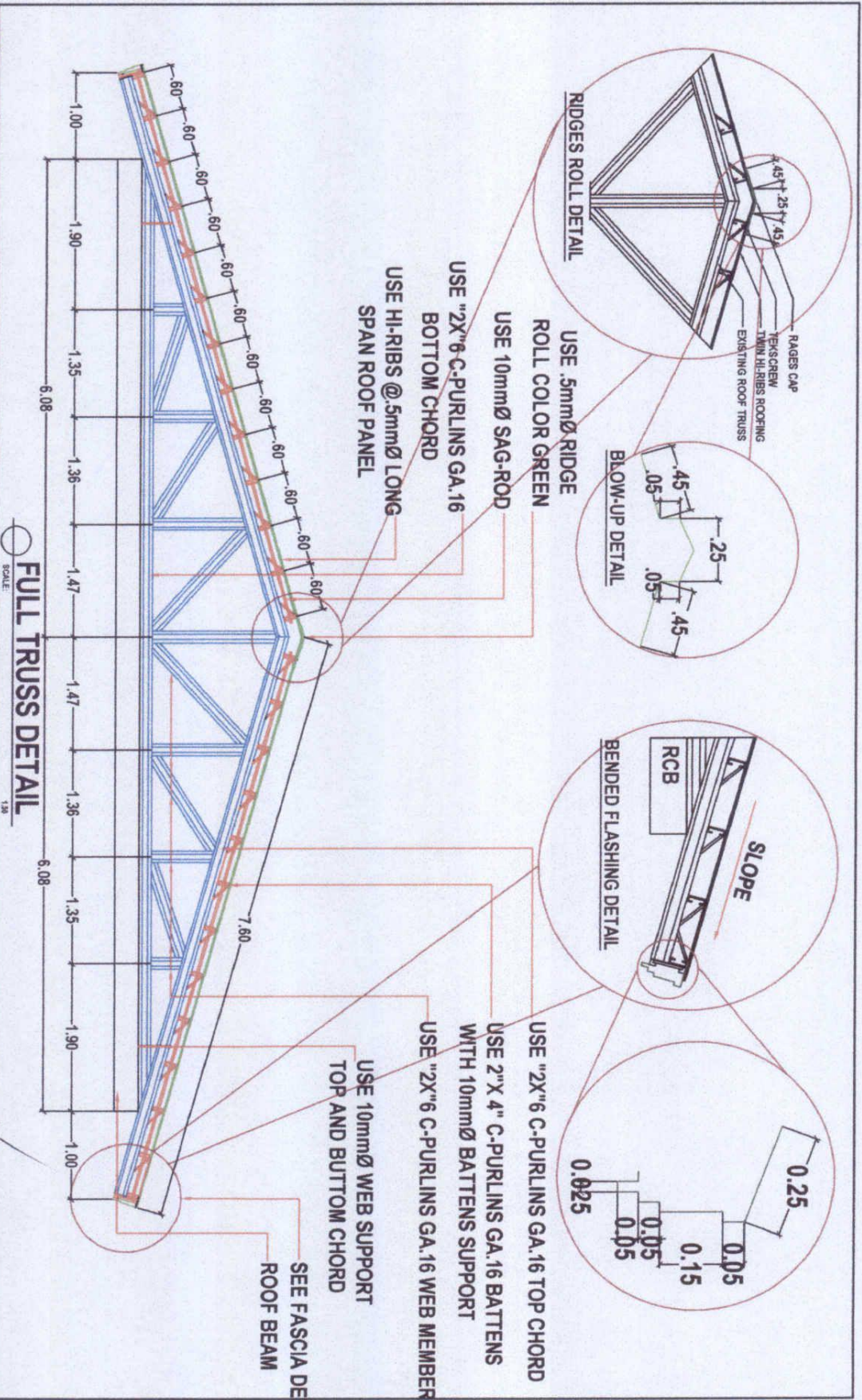



Republic of the Philippines
**CARLOS HILADO MEMORIAL
 STATE COLLEGE**
 Negros Occidental

PROJECT TITLE:
 UPGRADING TYPE BUILDING
 PHASE-1

ENDORSED BY:
 EDWIN H. BUDIA, Ph.D.
 CAMPUS DIRECTOR

CHECKED BY:
 ENRIL UPJUAN MANABANG
 DIRECTOR FROM

RECOMMENDING APPROVAL:
 MRS. ROSALINDA F. FUVILLA
 VICE PRESIDENT FOR ADMINISTRATION

APPROVED:
 NORBERTO P. MANAGUILABIVAN, Ph.D.
 SUC PRESIDENT III

PREPARED / CHECKED BY:
 FEDERICO V. DENISA, JR., Ph.D.
 CLAUDE P. ESCALANTE, Ph.D.
 L. BELARRINO
 CLAUDE P. ESCALANTE

S 3

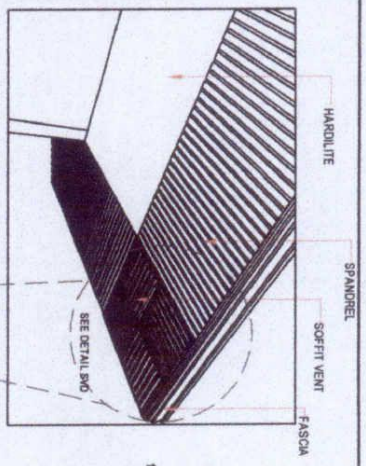

SPANDREL DETAIL
 SCALE: NDTs

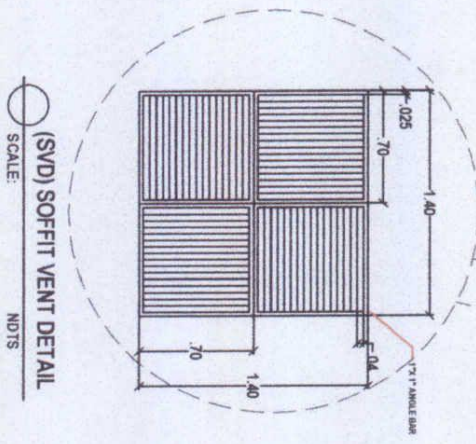

(SVD) SOFFIT VENT DETAIL
 SCALE: NDTs

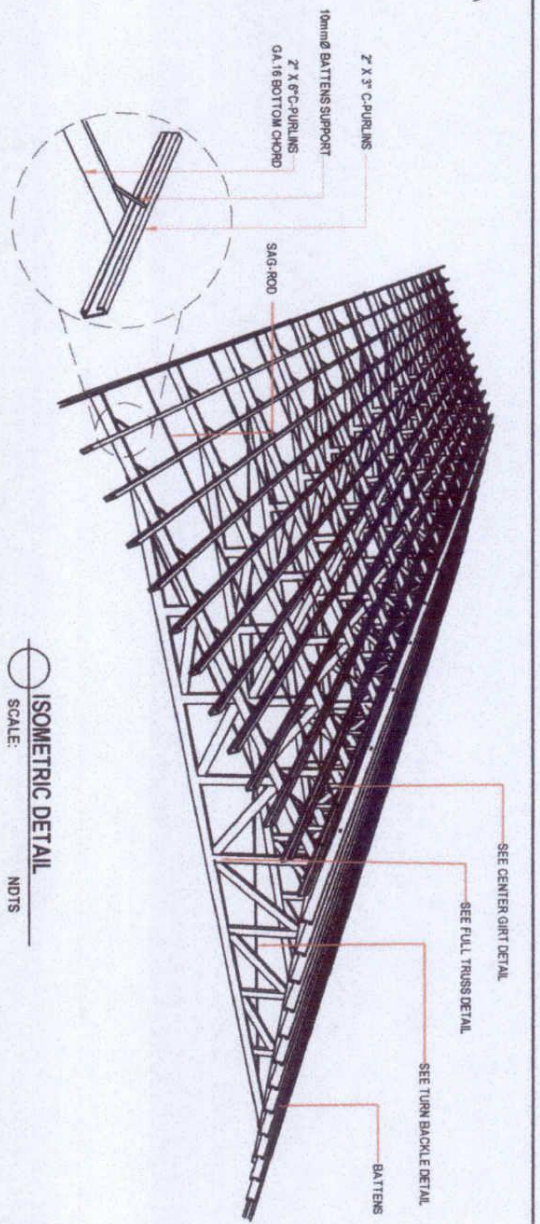

ISOMETRIC DETAIL
 SCALE: NDTs

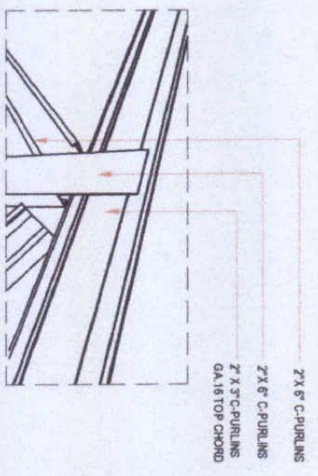

WEB MEMBER ATTACHED DETAIL
 SCALE: NDTs

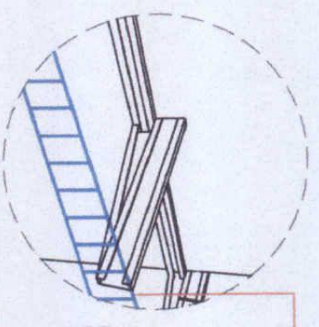

OVER HANG DETAIL
 SCALE: NDTs



Republic of the Philippines
**CARLOS HILADO MEMORIAL
 STATE COLLEGE**
 Negros Occidental

PROJECT TITLE:
 UPGRADING TYPE BUILDING
 PHASE - 1

ENDORSED BY:
 EDWIN H. BUONNA, Ph.D.
 CAMPUS DIRECTOR

CHECKED BY:

RECOMMENDING APPROVAL:
 VICE PRESIDENT FOR ADMINISTRATION

APPROVED:
 NORBERTO P. MANOQUE, Ph.D.
 SUC PRESIDENT III

PREPARED / CHECKED BY:
 FERDINAND DENISA JR., Ph.D.
 L. BELARRINO
 CAMPUS ENGINEER, PLANT AND FACILITIES
 CLERK DATA ROOM

SHEET NO. 4

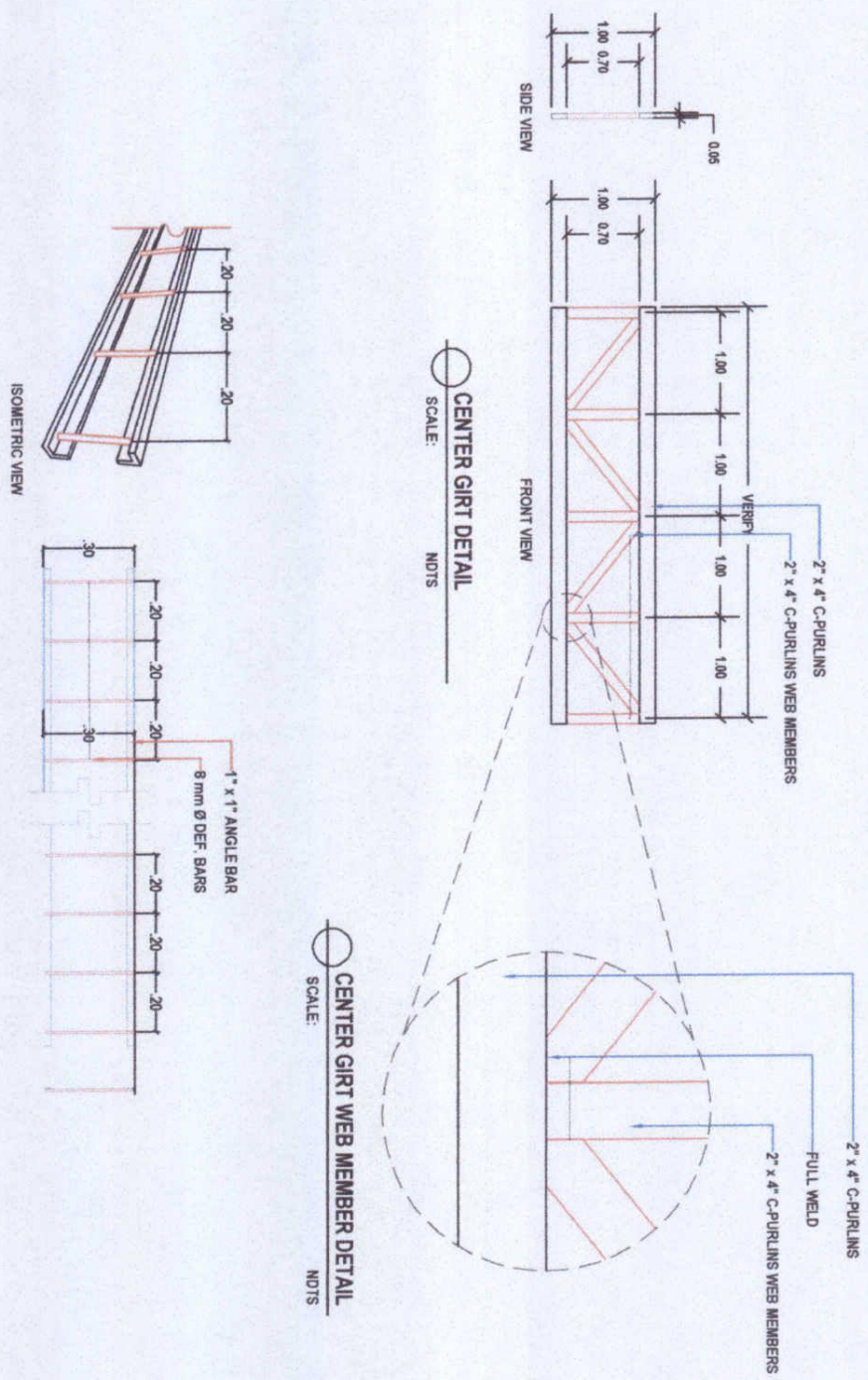

CENTER GIRTS DETAIL
 SCALE: N.D.T.S.

CENTER GIRTS WEB MEMBER DETAIL
 SCALE: N.D.T.S.

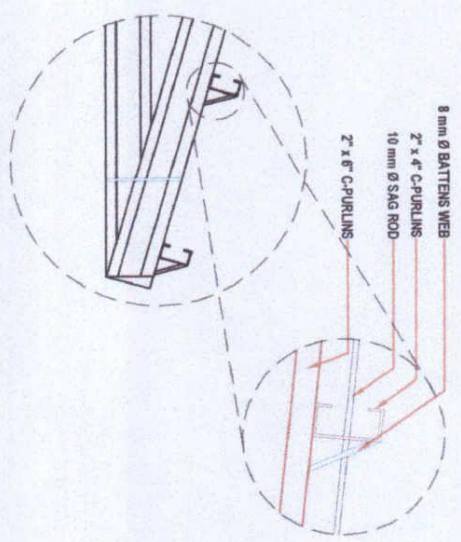

C-PURLINS DETAIL
SCALE: N.D.T.S.

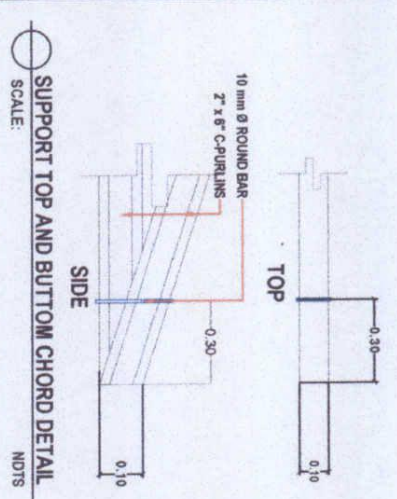

SUPPORT TOP AND BUTTOM CHORD DETAIL
SCALE: N.D.T.S.

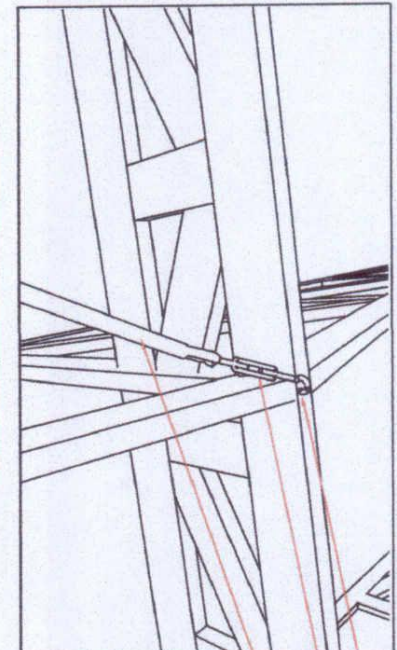

TURN BACKLE ATTACHEMENT DETAIL
SCALE: N.D.T.S.

 <p>Republic of the Philippines CARLOS HILADO MEMORIAL STATE COLLEGE Maguindanao</p>	PROJECT TITLE:	ENDORSED BY:	CHECKED BY:	RECOMMENDING APPROVAL:	APPROVED:	PREPARED / CHECKED BY:
	UPGRADING TYPE BUILDING PHASE: 1	EDWIN H. BUENA, Ph.D. CAMPUS DIRECTOR	Edwin H. Buena	MRS. ROSALINDA S. TAVALLA VICE PRESIDENT FOR ADMINISTRATION	NORBERTO P. MANOUJ/SENNA, Ph.D. SIC PRESIDENT III	FERRIC DENISA JR. Ph.D. L. BELARMINO CAMPUS STATE TRAINER
PROJECT LOCATION: ALVIE CAMPUS, MAGUINDANAO CITY						

55



Republic of the Philippines
**CARLOS HILADO MEMORIAL
 STATE COLLEGE**
 Negros Occidental

PROJECT TITLE:
 UPGRADING TVEP BUILDING
 PHASE-1

ENDORSED BY:

 EDWIN H. BUCINA, Ph.D.
 CAMPAIGN DIRECTOR

CHECKED BY:

 EDWIN H. BUCINA, Ph.D.
 CAMPAIGN DIRECTOR

RECOMMENDING APPROVAL:

 MRS. ROSALINDA S. DILLA
 VICE PRESIDENT FOR ADMINISTRATION

APPROVE:

 NORBERTO P. MANALO-LABMAN, Ph.D.
 SUC PRESIDENT III

PREPARED / CHECKED BY:

 FREDRICK V. DEBITA, JR., P.E.
 CAMPAIGN TECHNICAL ASSISTANT AND ARCHITECT

DESIGNED BY:
 L. BELTRANINO
 CAMPAIGN ARCHITECT

SHEET NO. 7

METAL FURRING OVER LAPPING DETAIL
 SCALE: NDTs

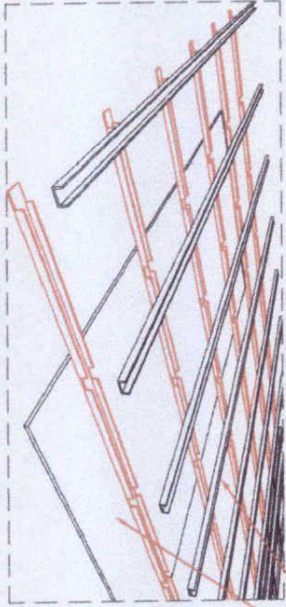

CEILING ISOMETRIC DETAIL
 SCALE: NDTs

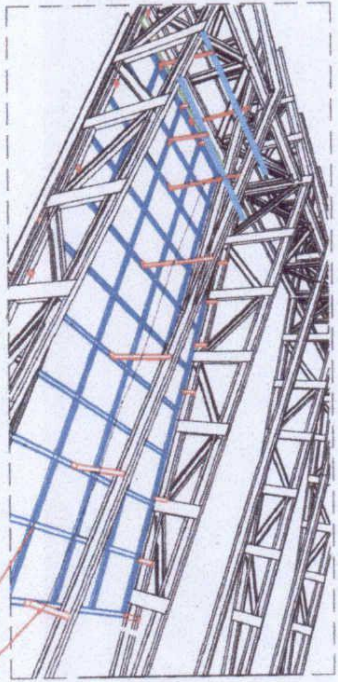

HANGING DETAIL
 SCALE: NDTs

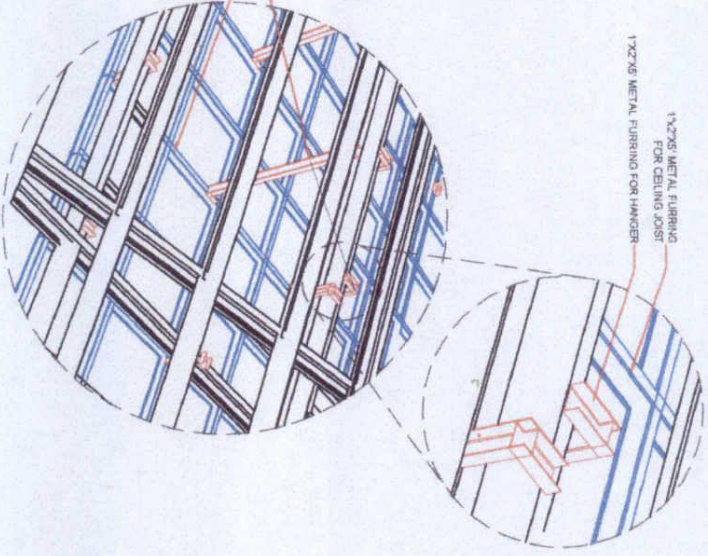



CARLOS HILADO MEMORIAL STATE COLLEGE
BIDS AND AWARDS COMMITTEE
 Talisay City, Negros Occidental
 Telefax No.: (034) 712-8404

Project Reference No : **CHMSC 21-035-0713-I**

Name of the Project : **UPGRADING OF TVEP BUILDING - PHASE I (LABOR AND MATERIALS)**

Location of the Project : **CHMSC-Alijis Bacolod City, Negros Occidental**

Scope of Works:

UPGRADING TVEP BUILDING (PHASE I)

Demolition Works

Dismantle of Roof Framing and Roof Claddings

Carpentry Works

Form Works

Metal Works

ROOFING and TRUSSES

Fascia Frames

Center Girt

Masonry Works

Concrete Roof Beam

Construction of Concrete Gable wall

Ceiling Works

Ceiling Joist and frames

Ceiling Paneling

Electrical Works

Reconnection of electrical wirings

Clearing and Hauling

* Other recommendation

Note: All Design & Plans Should

be referred to the identified

parameters.

*****Nothing follows*****

BILL OF QUANTITIES

Item No.	Description of Works	Qty	Unit	Material Cost		Labor Cost		Total Cost
				Unit Cost	Material Sub-Total Cost	Unit Cost	Labor Sub-Total Cost	
1.0	GENERAL REQUIREMENTS							
1.1	Mobilization/ Demobilization	1.0	lot					
1.2	Safety Occupational Hazards	1.0	lot					
	SUB-TOTAL							
2.0	Demolition Works							
2.1	Demolition of Roof Panels and Roof Trusses, (Affected Portion)	1.0	lot					
2.1	Hauling of waste materials	1.0	lot					
2.2	Clearing of site	1.0	lot					
	SUB-TOTAL							
3.0	CARPENTRY WORKS							
3.1.1	FORM WORKS							
3.1.2	Assorted Nail	15	kds					
3.1.3	2"x2"x 10' good lumber	10	pcs					
3.1.4	1/2 thk. Marine Plywood	6	pcs					
	SUB-TOTAL							
4.0	METAL WORKS							
4.1	ROOFING WORKS							
4.1.1	Twin Hi-Rib Type Long Span Green(.40x1.22x7.50)	72	sht					
4.1.2	Ridge Roll Green (.4x.610x2.44m)	18	sht					
4.1.3	Bended G.I Fascia Green (.4mx.915mx2.44m)	52	sht					
4.1.4	End Flashing Green (.4mx.915mx2.44m)	36	sht					
4.1.5	Elastomeric Sealant	2	qrt					
4.1.6	Touch up Paint (Green)	2	qrt					
4.1.7	Drillbit power craft 9/64 (US)	12	pc					
4.1.8	Texcrew (for roofing)	7000	pc					
4.1.9	Others Consumables	1	lot					
	SUB-TOTAL							

4.2	TRUSSES						
4.2.1	C-Purlins 1.5mm 2"x6"x20'	110	lgth				
4.2.2	C-Purlins 1.5mm 2"x3"x20'	116	lgth				
4.2.3	10mmØ x 6 m DSB	10	lgth				
4.2.4	Welding Rod 6013	3	box				
4.2.5	1Box(10Pcs) Tailin Super Thin Cutting Disc 4Inch (105x1.0x16mm)	7	box				
4.2.6	Steel Brush	12	pc				
4.2.7	Others Consumables	1	lot				
	SUB-TOTAL						
4.3	FASCIA FRAMES						
4.3.1	Angle steel Bar1"x1"x1/8"	45	lgth				
4.3.2	8 mm Ø Def BARS	28	lgth				
4.3.3	Hacksaw Blade (good quality) HS5 3ZTP1	12	pc				
4.3.4	Welding Rod 6013	1	box				
4.3.5	Cut Off #4 super thin	12	pc				
4.3.6	G.I Tie Wire #16	2	kl				
4.3.7	Diamond Cutting Blade 4"	6	pc				
4.3.8	Baby Roller 4"	6	pc				
4.3.9	Paint Tray (small)	6	pc				
4.3.10	METAL PRIMER (Zinc Chromate)	2	GALS				
4.3.11	Steel Brush	4	pc				
4.3.12	Others Consumables	1	lot				
	Sub-total,						
4.4	ROOF CENTER GIRT						
4.4.1	C-Purlins 1.2mm 2"x4"x20'	26	lgth				
4.4.2	Welding Rod 6013	2	box				
4.4.3	1Box(10Pcs) Tailin Super Thin Cutting Disc 4Inch (105x1.0x16mm)	2	box				
4.4.4	METAL PRIMER (Zinc Chromate)	4	GALS				
4.4.5	Paint Thinner	2	GALS				
4.4.6	Others Consumables	1	lot				
	SUB-TOTAL						
5.0	Masonry Works						
5.1	Construction of gable wall						
5.1.1	CHB 4" x 8" x 16"	300	pcs				
5.1.2	Mixing Sand	1.5	cu.m				
5.1.3	Mixing Gravel 3/4"	2	cu.m				
5.1.4	10 mm Ø x 6 m DSB	16	Lgths				
5.1.5	Acrylic Latex Paint Crisp Ecrú (Premium)	4	GALS				
5.1.6	Portland Cement (40 kgs) Premium	10	bag				
5.1.7	G.I Tie Wire #16	5	kl				
5.1.8	Others Consumables	1	lot				
	SUB-TOTAL						
5.2	Construction of Concrete Roof Beam						
5.2.1	Portland Cement (40 kgs) Premium	28	Bags				
5.2.2	Mixing Sand	3	cu.m				
5.2.3	Mixing Gravel 3/4"	3	cu.m				
5.2.4	10 mm Ø x 6 m DSB	24	Lgths				
5.2.5	G.I Tie Wire #16	5	kl				
	Sub-total,						

6.0	SOFFIT CEILING						
6.1.1	Spandrel Metal Ceiling White (@ 0.4mx 0.15m)	700	lm				
6.1.2	50MM THICKNESS – 1M X 50M insulator foam	10	roll				
6.1.3	Metal furring 1"x2"	90	lght				
6.1.4	Wall Angle	70	lght				
6.1.5	Blind Rivets 1/8 x 1/2 -1000 pcs.	4	Box				
6.1.6	Others Consumables	1	lot				
	SUB-TOTAL						
6.2	Ceiling Works (Joist and Paneling)						
6.2.1	Fiber Cement board 3.5mm	125	sht				
6.2.2	Metal furring 1"x2"	420	lght				
6.2.3	Wall Angle	70	lght				
6.2.4	Blind Rivets 1/8 x 1/2 -1000 pcs.	16	Box				
	Others Consumables	1	lot				
	SUB-TOTAL						
7.0	ELECTRICAL WORKS						
7.1	Reconnection of electrical Wirings (affected portion)	2	lot				
7.1	5.5 mm ² THHN Stranded	2	rolls				
7.1	2.0 mm ² THHN Stranded	1	rolls				
7.1	Flexible Hose Electrical Orange Conduit 1/2 " x 50m	3	roll				
7.1	Flexible Hose Connector	80	pcs				
7.1	Junction Box (octagonal)	20	pcs				
7.1	Others Consumables	1	lot				
	Sub-total,						
						A. TOTAL DIRECT COST	-
						B. CONSUMABLES	
						C. SUPERVISION AND ADMINISTRATION	
						D. TOTAL INDIRECT COST (B + C)	
						E. TOTAL COST (A + D)	
						F. VAT (12% of Item E)	
						GRAND TOTAL OF PROJECT COST	
PROJECT DURATION: 90 DAYS							